



samamco
INDUSTRIAL SOLUTION

BUSINESS PROFILE

2026

+966 532066717

www.samamcoksa.com

P.O Box 34427, AlKhobar, Saudi Arabia.

Who We Are

Founded in **2016**, **Samam Al Khair Trading Company** has established itself as a premier specialist in high-performance fuel systems and pumping solutions. We serve as the vital link between global engineering excellence and local industrial requirements, providing integrated systems that ensure the safe, precise, and efficient movement of critical fluids.

While our capabilities span across project supplies and fabrication, our core identity is defined by our mastery of **Fuel Infrastructure**. From high-volume industrial pump skids to automated monitoring systems, we provide the technical backbone for sectors that cannot afford downtime. At **Samam Al Khair**, we combine premium global brands with local technical support to deliver "A to Z" solutions for the modern energy and industrial landscape.

ISO 9001 2015 Certified Company.



Projects

- **Trian Island** - Fuel transfer pumps, tank accessories, and related materials.
- **Amak** - High-capacity pumping systems & specialized tank accessories for remote site infrastructure.
- **NEOM** - Supplied high-capacity fuel transfer skids for heavy machinery.
- **Oxagon** - Fuel transfer pumps, tank accessories, and related materials.
- **Trojina** - Fuel transfer pumps, tank accessories, and related materials.
- **Aramco-Approved Projects (Ras Tanura)** - High-quality Aramco-approved material supply.

Projects In Transit

- **Fuel Transfer Systems** - Ongoing installation and commissioning of fuel transfer systems for various clients.
- **Tank Leak Detection Systems** - Ongoing installation and commissioning of tank leak detection systems for various clients.

Dedicated to providing excellence in service throughout the Kingdom.



Collaborative Partners



What We Provide

Service isn't just a department for us—it's our specialty. We partner with you at every stage, providing the strategic consultation and technical design needed to bring your project to life. Whether it's pre-installation planning or post-installation support, we are committed to delivering results that align with your vision. Our services include:



Consulting



Documentation



Site Support



After Sales

Our Services



Consulting

FMS Automation
Skid Vibration Analysis
Skid Alignment Analysis

Fuel Systems

Leakage Detection Systems
Fuel Management Systems
Fuel Transfer Systems



Project Supplies

Specialized Equipment
Safety Equipments
Tools

Fabrication

Fuel Storage Tanks
Pump Skid Fabrication
Precision Welding Fabrication

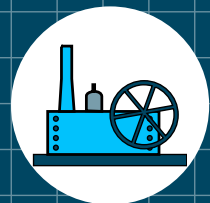

Skid Accessories



Valves



Flowmeters

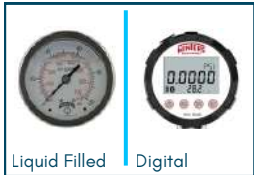

Gauges

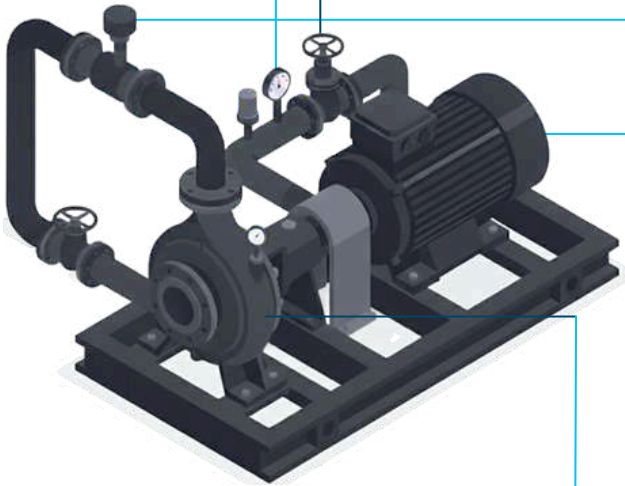

Pumps

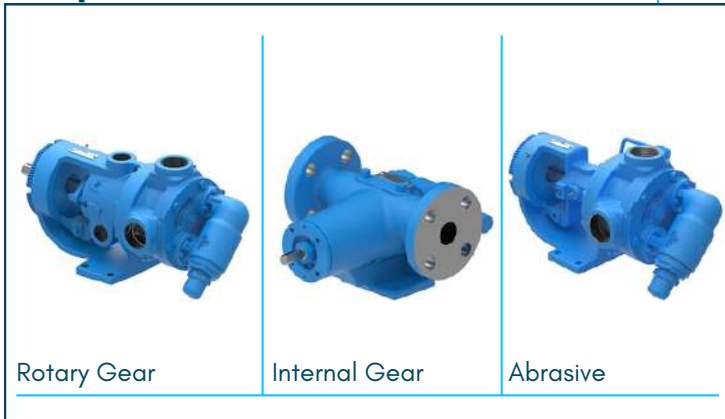

Motors

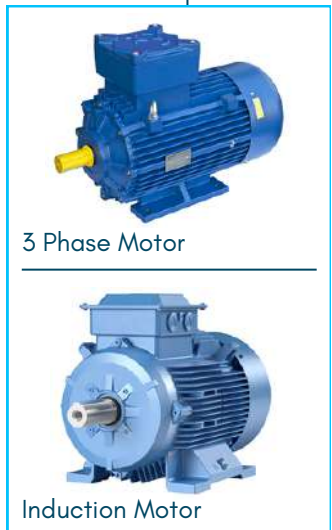

Pumps

VIKING PUMP



4124 Series



4193 Series



4224 Series



4194 Series

WILDEN



PS Series



PO Series



P Series



PI Series

 **Pompas Intercal**
bombas centrifugas



Sea Water Pumps



Vertical Pumps



Turbine Pumps



Centrifugal Pump

euromotori



Atex Motor



3P Motor

ABB



Induction Motor



Synchronous Motor



Flow Equipment



G2 Series



OM Series



TM Series



4194 Series



M Series



MS Series



Digital Registers



Smart Registers



F Series



E Series



B Series



C Series



M Series



A Series



Digital Meter



Mechanical Meter

Fuel Visibility: Total Control in Real-Time



REAL-TIME FUEL TRACKING

Monitor movement and consumption across every site instantly to eliminate delays.



PRECISE AIR-FREE MEASUREMENT

New flow meters include built-in air eliminators for 100% accurate fuel calculations.



INSTANT VARIANCE & LEAK DETECTION

Compare delivery vs. consumption data to quickly identify losses or reporting gaps.



MAXIMIZE SITE AVAILABILITY

Proactive issue management ensures sites remain operational with optimized fuel logistics.

Automation Chain

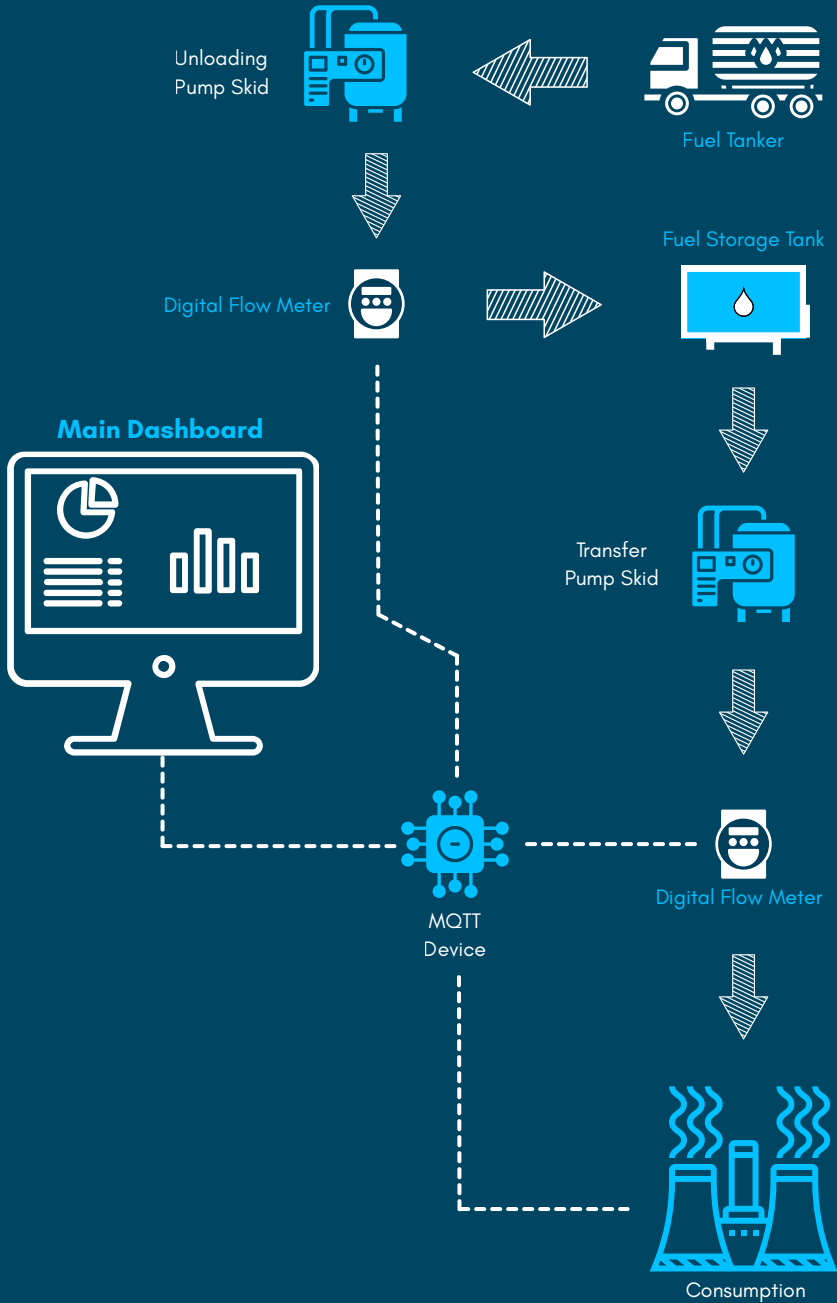

Tank Accessories

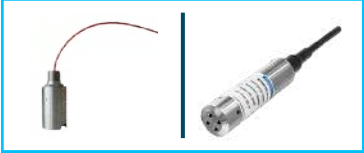

Sensor



Flame Arrestors



2" TO 10"

Vents



Indicators

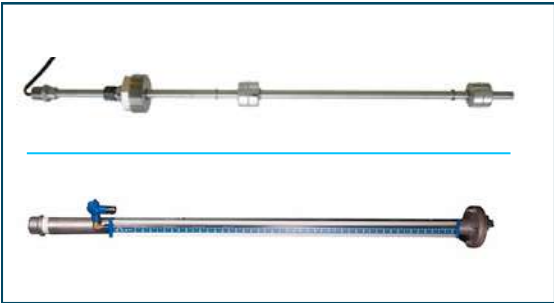

Alarms



Tank Accessories

Morrison Bros. Co.
Established 1855

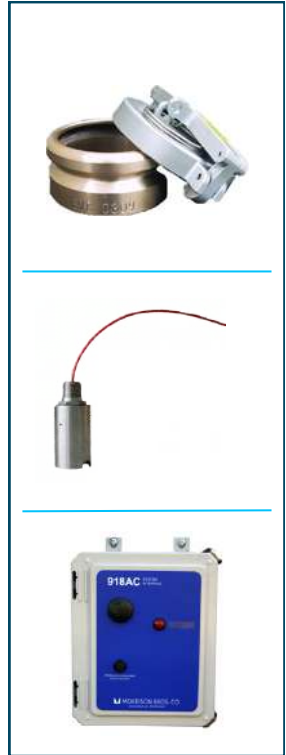

RIDART



HYTEK
FUELLING EQUIPMENT



Storage Tanks



Container Tanks

Applications:

 Diesel

 Petrol



Capacity

20m³

25m³

30m³



Self Bunded Tanks



Applications:

 Diesel

 AdBlue

Capacity

10m³

20m³

30m³



Eco Tanks



Applications:

 Diesel

 AdBlue

 Water



Capacity

07m³

10m³

12m³

Pipes & Cables

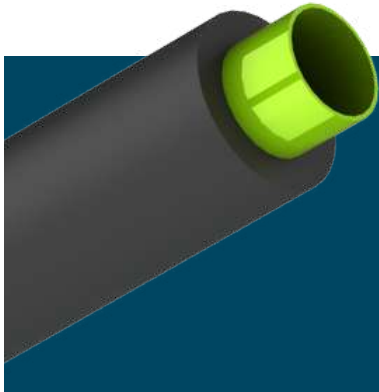

Double-Wall Pipe

Applications:



- Diesel
- Water
- Petrol
- AdBlue

Diameters

32MM — 90MM



Single-Wall Pipe



Applications:

- Diesel
- AdBlue

Diameters

32MM — 90MM

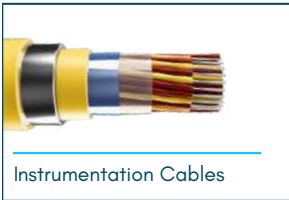
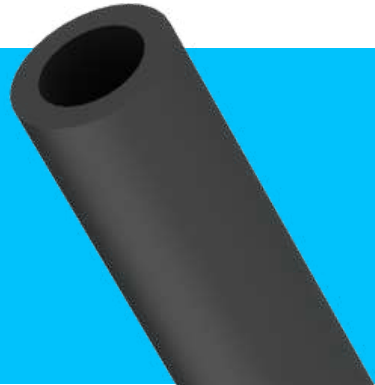

Instrumentation Cables

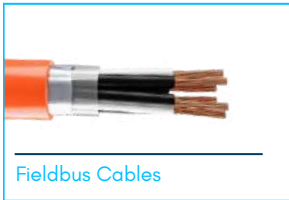

Fieldbus Cables

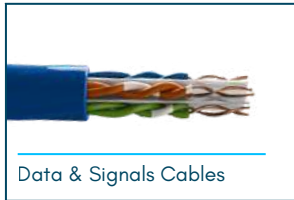

Data & Signals Cables

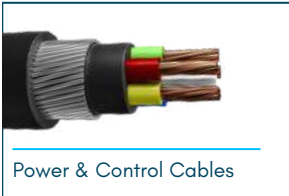

Power & Control Cables

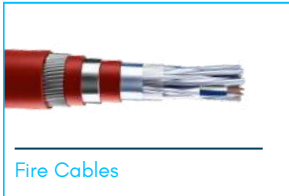

Fire Cables

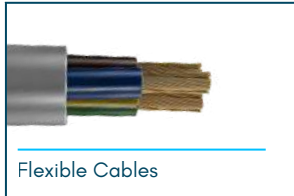

Flexible Cables

Extended Service

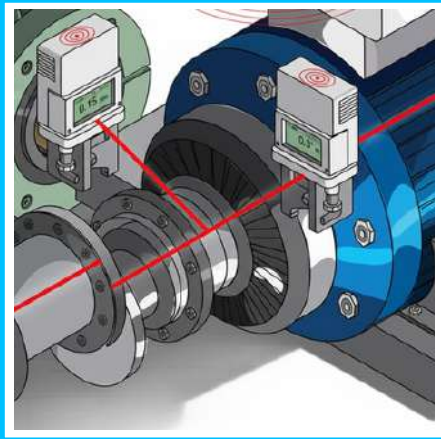

Pump Alignment Analysis

Skid Vibration Analysis



Dry Break Couplings & Safety Break-Aways



TODO Safety Break-Aways, Dry Break Couplings (From 1" to 6") & accessories. Trusted around the world to transfer highly valuable & volatile products in the most testing conditions.

Hoses



Rubber Suction/
Discharge Hoses



Composite Suction/
Discharge Hoses



Hydraulic Hoses



PVC Hoses



Stainless Steel Braided
Hoses

We take pride in our ability to offer the most comprehensive and technically sophisticated range of hose products available anywhere in the world. Our hoses have been tested to last many times longer than anything currently on the market.

Hose Fittings & Couplings



Camlock
Couplings



King
Nipples



Bauer
Couplings



Miller
Couplings



Chicago Quick
Couplings



Storz
Couplings



Straub
Couplings



Hammer
Unions

We carry a comprehensive range of quick connect/disconnect couplings and replacement parts for the petroleum, industrial, chemical, tank truck, marine and aviation markets.

LPG Valves & Accessories



Relief
Valves



Regulators



Cylinder & service valves



Diversers



LPG
Nozzles

Pressure control, flow control, relief valve solutions for specialty gases, liquids, steam, natural gas and liquid propane industries across a range of stationary storage & mobile applications.



samamco
INDUSTRIAL SOLUTION

CONTACT US

sales@samamcoksa.com

www.samamcoksa.com

+966 532066717

King Khalid St, 13th Cross, Ash Shamaliya, Al Khobar,
Saudi Arabia.



رؤية
VISION
2030
المملكة العربية السعودية
KINGDOM OF SAUDI ARABIA